

**FOR INFORMATION ONLY:
DO NOT MANUFACTURE
PARTS TO THIS DRAWING**

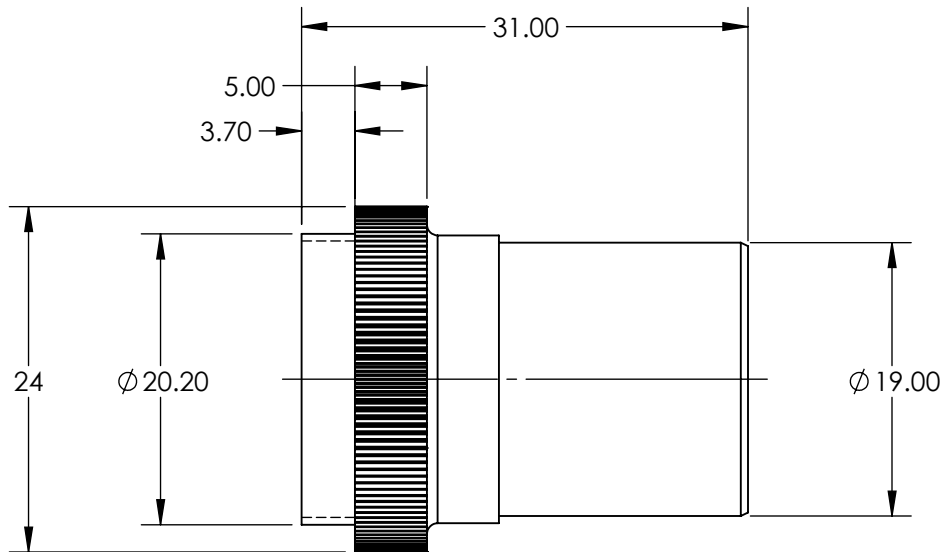

EFFECTIVE FOCAL LENGTH EFL (mm)	4.65
MAGNIFICATION	40X
MOUNTING THREAD	0.7965-36 TPI, 55° Whitworth
NUMERICAL APERTURE NA	0.65
WORKING DISTANCE (mm)	0.48
LENGTH EXCLUDING THREADS (mm)	45.8
MAXIMUM DIAMETER (mm)	24
TYPE	Achromatic, Spring-Loaded
RoHS	NOT COMPLIANT

SPECIFICATIONS SUBJECT TO CHANGE WITHOUT NOTICE
DIMENSIONS ARE FOR REFERENCE ONLY

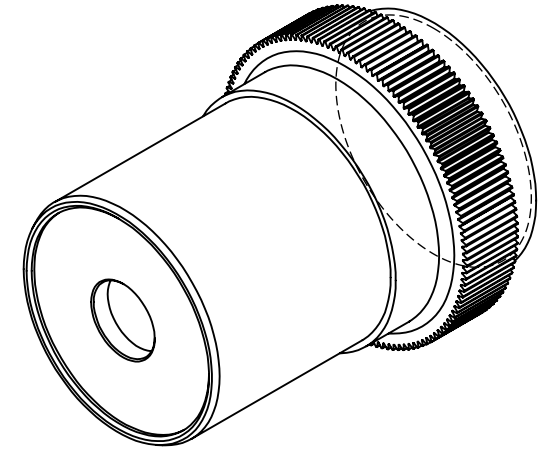

ALL DIMS IN

mm

TITLE

40X DIN Achromatic Commercial Grade Objective

DWG NO

43904

SHEET
1 OF 1