

NOTES:

1. SUBSTRATE: Silicon (Si)
2. SURFACE S2 TO BE PARALLEL TO S1 WITHIN <3 ARCMIN
3. COATING (APPLY ACROSS CLEAR APERTURE)

S1 & S2: NONE

4. FINE GRIND SURFACE (ADD INK NOTE AS NEEDED)

5. ROHS COMPLIANT

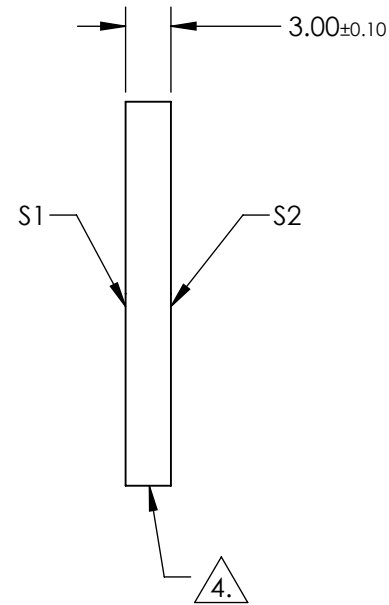
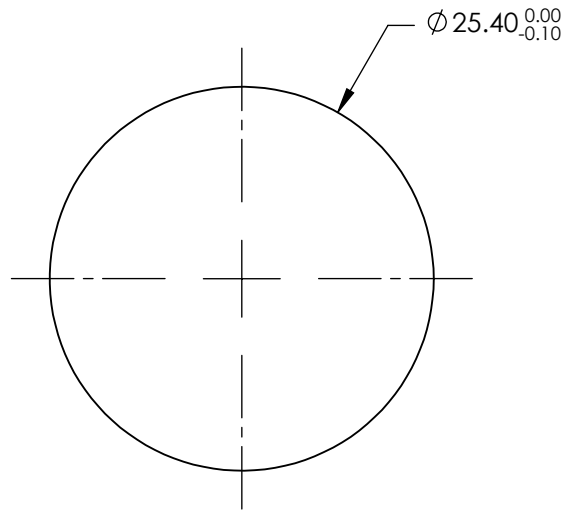
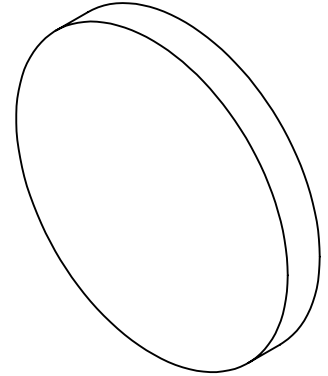

**FOR INFORMATION ONLY:
DO NOT MANUFACTURE
PARTS TO THIS DRAWING**

SPECIFICATIONS SUBJECT TO CHANGE WITHOUT NOTICE
DIMENSIONS ARE FOR REFERENCE ONLY

	S1	S2
SHAPE	PLANO	PLANO
SURFACE QUALITY	60-40	60-40
CLEAR APERTURE	∅ 22.9	∅ 22.9
SURFACE FLATNESS	1λ	1λ
BEVEL	PROTECTED AS NEEDED	PROTECTED AS NEEDED

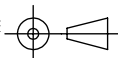
THIRD ANGLE PROJECTION 

ALL DIMS IN mm

EO® Edmund Optics®

TITLE: 25.4mm Dia. x 3.0mm Thickness Uncoated, Silicon Window

DWG NO: 20020

SHEET 1 OF 1