

NOTES:

1. WAVELENGTH RANGE: 400 - 700nm:
2. COATING: UNCOATED
3. FINE GRIND SURFACE
4. ROHS COMPLIANT

**FOR INFORMATION ONLY:  
DO NOT MANUFACTURE  
PARTS TO THIS DRAWING**

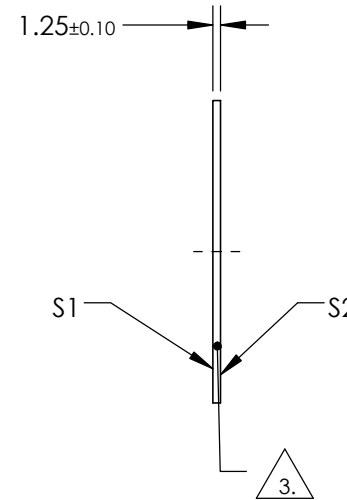
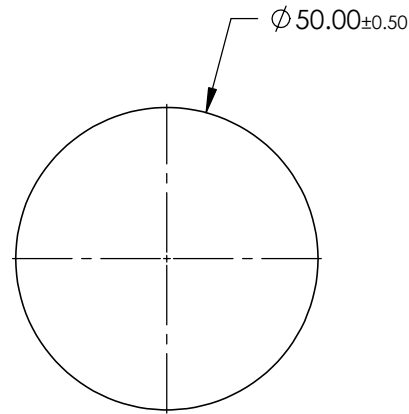
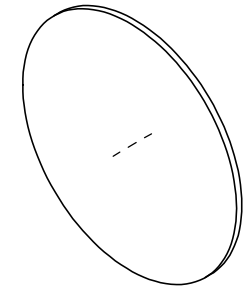

SPECIFICATIONS SUBJECT TO CHANGE WITHOUT NOTICE  
DIMENSIONS ARE FOR REFERENCE ONLY

**EO**® **Edmund Optics**®

	S1	S2
SHAPE	PLANO	PLANO
SURFACE ACCURACY	COMMERCIAL POLISH	COMMERCIAL POLISH
SURFACE QUALITY	80-50	80-50
BEVEL	PROTECTIVE AS NEEDED	PROTECTIVE AS NEEDED

THIRD ANGLE PROJECTION

ALL DIMS IN mm

TITLE	50mm DIA. WHITE DIFFUSING GLASS	
DWG NO	34475	SHEET 1 OF 1