

NOTES:

1. SUBSTRATE MATERIAL:
FUSED SILICA

2. COATING (APPLY ACROSS CLEAR APERTURE)

S1: R(abs)= 30% ±5% @ 350nm, 45° AOI
 R(avg)= 30% ±10% OVER 250 - 450nm, 45° AOI
 T(abs)= 70% ±5% @ 350nm, 45° AOI
 T(avg)= 70% ±10% OVER 250 - 450nm, 45° AOI

S2: BBAR (R(avg) <1%, R(abs) <2% OVER 250 - 450nm), 45° AOI

 EDGE FINE GROUND

4. ROHS COMPLIANT

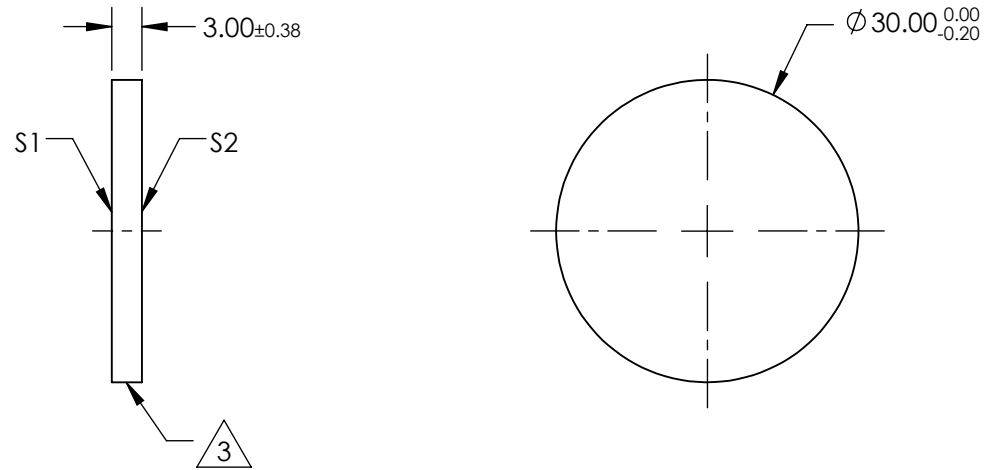

**FOR INFORMATION ONLY:
DO NOT MANUFACTURE
PARTS TO THIS DRAWING**

SPECIFICATIONS SUBJECT TO CHANGE WITHOUT NOTICE
DIMENSIONS ARE FOR REFERENCE ONLY

REV. A	S1	S2
SHAPE	PLANO	PLANO
CLEAR APERTURE	Ø25.50	Ø25.50
SURFACE QUALITY	60-40	60-40
SURFACE FLATNESS	1λ	1λ
BEVEL	PROTECTED AS NEEDED	PROTECTED AS NEEDED

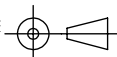
THIRD ANGLE PROJECTION 

ALL DIMS IN mm

 **Edmund Optics®**

TITLE: Ø30mm, 30R/70T, UV PLATE BEAMSPLITTER

DWG NO: 65926

SHEET 1 OF 1